

4 3 2 1

F

F

E

E

D

D

C

C

B

B

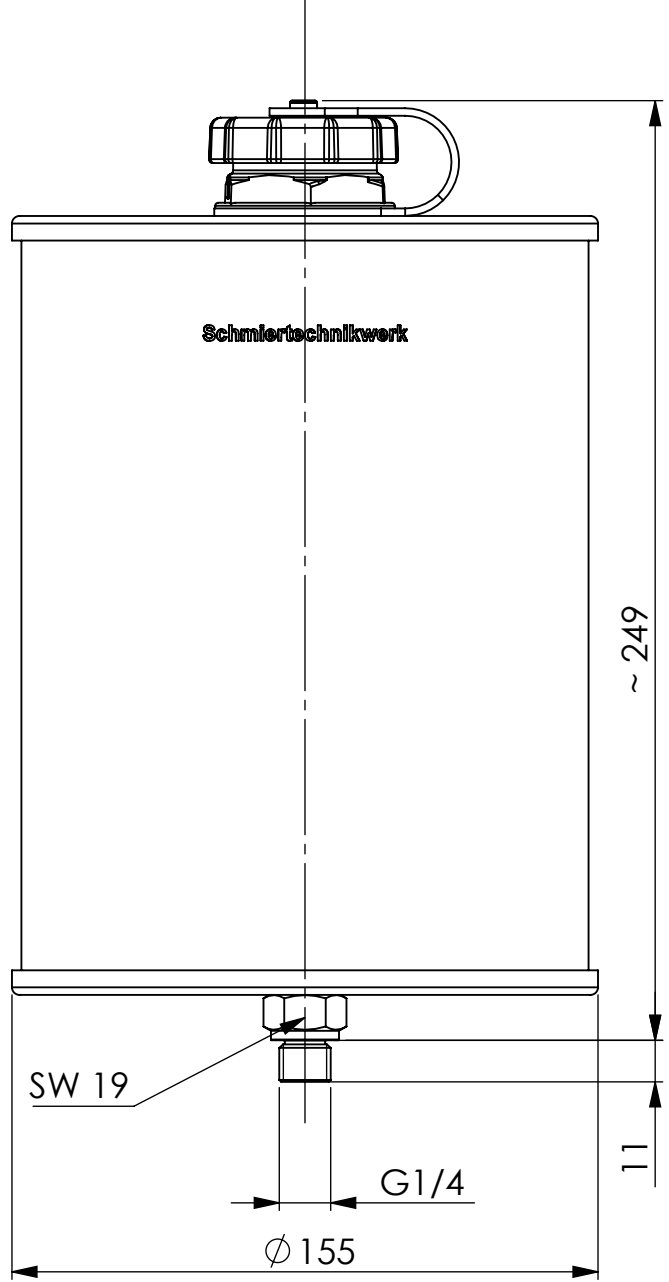
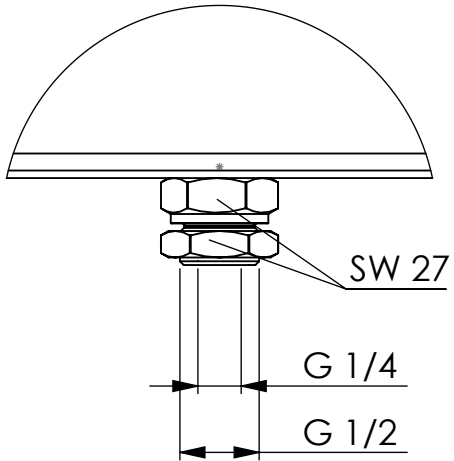

A

A

				<b>Datum</b>	<b>Name</b>	<b>Benennung</b>
			<b>Bear.</b>	12.06.2023	H.Hanke	TopTank Novum 3000
			<b>Gepr.</b>		K.F.	
			<b>Norm</b>			
						<b>Zeichnungsnummer</b>
						000 08 300 XX XX
<b>Zust.</b>	<b>Änderung</b>	<b>Datum</b>	<b>Name</b>	<b>Maßstab</b>	<b>1:2</b>	<b>BLATT 1 VON 1</b>

4 3 2 1